

# Concealed Dual-Flush Technology Tank (UP720) and Carrier System for Wall-Hung Washdown Toilets



Model 111.728.00.1\*

## Product Specifications

Carrier system and concealed tank with actuator flush panel or pneumatic push button for residential washdown wall-hung toilets. System shall fit within 3 1/2" (90 mm) framing wall or plumbing chase. Framing members should provide support similar to 2" x 4" (51 mm x 102 mm) wood construction or steel framing members placed 23 1/4" (590 mm) apart. Water supply shall have flow diameter no smaller than 1/2" (13 mm) copper tube, and a minimum flow pressure of 2 PSI (0.01 MPa). The toilet bowl shall be a third party listed low-consumption 1.6 GPF (6 LPF) or 1.6/0.8 GPF (6/3 LPF) dual-flush 2-hole wall-hung type. The carrier frame shall be adjustable for bowl rim heights from 15" to 19" (381 to 483 mm). Actuator flush panels shall be diecast zinc,

molded plastic or fabricated stainless steel and plated to preserve material integrity. All components shall be compliant with applicable codes and product standards.

## Warranty

Limited lifetime warranty on tank and carrier, 10-year warranty on fill valve and flush valve. One-year warranty on actuator flush panels.

## Features

- Water consumption – Dual-flush system allows 1.6/0.8 GPF (6/3 LPF), giving effective flush volume of 1.1 GPF (4 LPF)
- Anti-siphon fill valve
- Impact resistant high density polyethylene (HDPE) tank, insulated to prevent condensation

- 16-gauge, powder-coated, structural-steel tubing rated to 880 lbs. (400 kg) without damage to finished wall or carrier unit
- Bowl rim height adjustments from 15" to 19" (381 to 483 mm)
- 47" (1200 mm) frame height
- For finished walls up to 3.5" (9 cm) thick
- Medium inspection opening for flush actuator plates Sigma, Bolero, Samba, Mambo, Tango, Rumba
- Includes installation and rough-in materials

Complies with the latest editions of:

- ASME: A112.6.2, A112.19.5, A112.19.14
- ANSI Z124.4
- CSA B125.3
- ANSI/ASSE 1002
- IAPMO PS-50
- UNAR / UNAR-HET
- ASME A112.19.2 and WaterSense® compliant when matched to properly approved bowl

\*Product Available Q4 2010

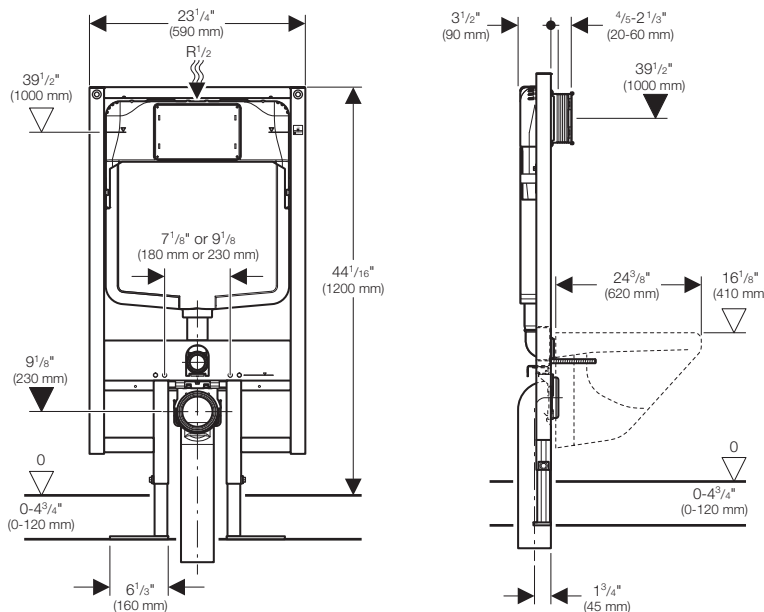

Product specifications subject to change without notice.



### ARCHITECT/ENGINEER APPROVAL

Job Name \_\_\_\_\_

Date \_\_\_\_\_ Quantity \_\_\_\_\_

Model Specified \_\_\_\_\_

Variations Specified \_\_\_\_\_

Customer/Wholesaler \_\_\_\_\_

Contractor \_\_\_\_\_

Architect \_\_\_\_\_

Geberit  
2100 S. Clearwater Drive  
Des Plaines, IL 60018

800/566-2100  
Fax 847/803-5454  
www.geberit.us

GEB6107 03/10

GNA7094 03/10

# Optional Accessories for Wall-Hung Washdown Toilet Carrier 111.728.00.1



## Product Specifications

Installation accessories for concealed tank and carrier for wall-hung toilet. Accessories shall be for alternate frame installation and connection sets between carrier and toilet fixture.

## Warranty



One-year warranty against manufacturers' defect.

## Features



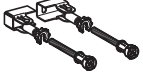
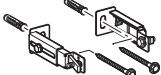

Installation accessories for:

- Pre-wall installation
- Corner installation
- Post-tension concrete floors
- Supports for short height wall-hung bowls
- Connection set for 1" seat height offset
- Sound dampening pad
- Alternate bolt caps
- Finished wall thicknesses to 7.09" (18 cm)

## Mounting Accessories for Carrier Frames

Description	Model No.
 Frame to wall anchoring for 5.12"–7.87" (13–20 cm) thick unfinished pre-wall corner installations	111.835.00.1 <sup>†</sup>
 Frame to wall anchoring where foot installations into floor are not allowed for 5.12"–7.87" (13–20 cm) thick unfinished pre-wall	111.867.00.1 <sup>†</sup>
 Frame to wall anchoring extensions for 7.87"–15.75" (20–40 cm) thick unfinished pre-wall	111.887.00.1 <sup>†</sup>

## Waste Fittings

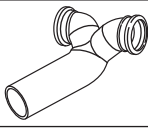
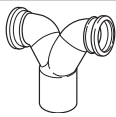
	HDPE straight connector with socket for 03.54" (090 mm) push fit piping and 03.54" (090 mm) outlet x 12" (31 cm) long	366.887.16.1
	HDPE connector with offset for LH horizontal drain connections (as viewed from sitting position), 1 x 90° bend with socket for 03.54" (090 mm) push fit piping, with 45° offset and 03.54" (090 mm) outlet	366.913.16.1
Note: 5.5" minimum walls only		
	HDPE connector with offset for RH horizontal drain connections (as viewed from sitting position), 1 x 90° bend with socket for 03.54" (090 mm) push fit piping, with 45° offset and 03.54" (090 mm) outlet	366.914.16.1
Note: 5.5" minimum walls only		
	Cast iron outlet bend; 1 x 90° bend with socket for 03.54" (090 mm) push fit piping and 3" CIP outlet	367.071.18.1
	HDPE "Back-to-back" connector for horizontal drain connections; 2 x 90° bends with sockets for 03.54" (090 mm) push fit piping, with 45° offset and expansion to 04.33" (0110 mm) outlet	367.485.16.1
Note: 10.75" minimum walls only		
	HDPE "Back-to-back" connector for vertical drain connections; 2 x 90° bends with sockets for 03.54" (090 mm) push fit piping and expansion to 04.33" (0110 mm) outlet	367.923.16.1
Note: 10.75" minimum walls only		

<sup>†</sup> Special order. Up to 4 weeks delivery. Contact your Geberit sales representative or customer service for more information. Continued on other side

Product specifications subject to change without notice.



ARCHITECT/ENGINEER APPROVAL	
Job Name	_____
Date	_____
Quantity	_____
Model Specified	_____
Variations Specified	_____
Customer/Wholesaler	_____
Contractor	_____
Architect	_____



Geberit  
2100 S. Clearwater Drive  
Des Plaines, IL 60018

800/566-2100  
Fax 847/803-5454  
www.geberit.us



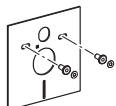

# Optional Accessories for Wall-Hung Washdown Toilet Carrier 111.728.00.1

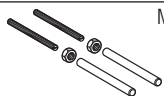

## Bowl Connection Sets and Accessories

Description	Model No.
 <p>HDPE connection set with 1" (2.5 cm) offset and mounting hardware (bowl installation kit); with socket for Ø3.54" (Ø90 mm) push fit piping and Ø55 supply inlet; Matte Chrome cover caps</p>	405.116.00.1†
 <p>Acoustic insulation set for wall-hung toilets and bidets</p>	156.050.00.1
 <p>Connector set with mounting hardware (bowl installation kit), HDPE; Alpine White cover caps</p>	152.404.11.1
 <p>Cover caps with leveling washer, Plastic, Alpine White</p>	217.713.11.1

## Required Accessories for 3.54"-7.09" (9-18 cm) Finished Wall Thickness

 <p>Mounting rod extension set for wall-hung toilet and bidet, M12</p>	242.232.00.1†
 <p>Mud guard protection housing for UP320/UP720, Plastic</p>	241.826.00.1
 <p>Extension set for actuator flush plates compatible with UP320, UP300, UP720 and UP200 flush tanks</p>	240.938.00.1†
 <p>HDPE Connector set for extended installation and mounting hardware (bowl installation kit), with socket for Ø3.54" (Ø90 mm) push fit piping and Ø55 supply inlet; matte chrome cover caps</p>	152.438.46.1†

† Special order. Up to 4 weeks delivery. Contact your Geberit sales representative or customer service for more information.

Product specifications subject to change without notice.

Geberit  
2100 S. Clearwater Drive  
Des Plaines, IL 60018

800/566-2100  
Fax 847/803-5454  
www.geberit.us

GEB6116 09/10

GNAT104 09/10

# Dual-Flush Actuators for Wall-Hung Washdown Toilet Carrier 111.728.00.1



## Product Specifications

Actuators for residential concealed tank and carrier system. Actuator flush panels and Push Buttons shall be zinc die-cast, molded plastic or fabricated stainless steel and plated to guard against scratches. All components shall be compliant with applicable codes and product standards.

## Dimensions

### Dual-Flush Actuator Plates

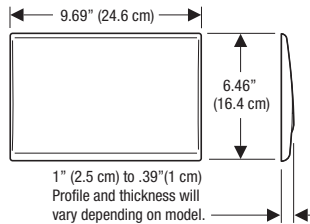

## Finishes

### Dual-Flush Actuator Plates for 111.728.00.X Toilet Carrier (UP720 flush tank)

Style	Material	Finish	Model No.
Sigma50	Zinc die cast	Customer defined	115.788.00.1†
		Alpine White	115.788.11.1†
		Black	115.788.DW.1†
		Pergamon	115.788.EP.1†
		White Pattern Glass	115.788.SC.1†
		Smoke Glass	115.788.SD.1†
Sigma20	Plastic	Green Satin Glass	115.788.SE.1†
		Gloss-Matte-Gloss*	115.778.KH.1†
		White-Gloss-White*	115.778.KJ.1†
		Black-Gloss-Black*	115.778.KM.1†
		Bolero	Plastic
Bolero	Plastic	Polished Chrome	115.777.21.1
		Matte Chrome	115.777.46.1
Samba	Plastic	Alpine White	115.770.11.1
		Polished Chrome	115.770.21.1
		Matte Chrome	115.770.46.1

\*Colors follow this pattern = Plate/Ring/Button

\*\*Colors follow this pattern = Frame/Button

† Special order. Up to 4 weeks delivery. Contact your Geberit sales representative or customer service for more information.

## Warranty

One-year warranty on actuator flush panels.

## Features

- Designed to maintain appearance push after push
- Moving parts are accessible behind actuator flush panel
- Made of molded plastic, zinc die cast or stainless steel and plated
- Available in 13 designer finishes
- Incorporates water saving possibilities with dual-flush buttons of 1.6 GPF (6 LPF) or 0.8 GPF (3 LPF) giving an effective flush volume of 1.1 GPF (4 LPF)



ARCHITECT/ENGINEER APPROVAL	
Job Name	_____
Date	_____
Quantity	_____
Model Specified	_____
Variations Specified	_____
Customer/Wholesaler	_____
Contractor	_____
Architect	_____

Product specifications subject to change without notice.

Geberit  
2100 S. Clearwater Drive  
Des Plaines, IL 60018

800/566-2100  
Fax 847/803-5454  
www.geberit.us

GEB6118 08/10

GNAT105 08/10

# Single-Flush Actuators for Wall-Hung Washdown Toilet Carrier 111.728.00.1



## Product Specifications

Actuators for residential concealed tank and carrier system. Actuator flush panels and Push Buttons shall be zinc die-cast, molded plastic or fabricated stainless steel and plated to guard against scratches. All components shall be compliant with applicable codes and product standards.

## Dimensions

Single-Flush Actuator Plates (Fig. 1)

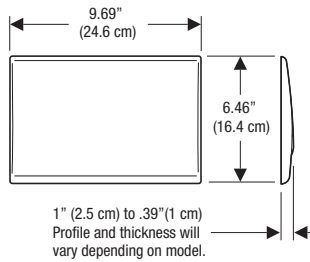

HyTouch WC Square Single-Flush Push Button (Fig. 2)

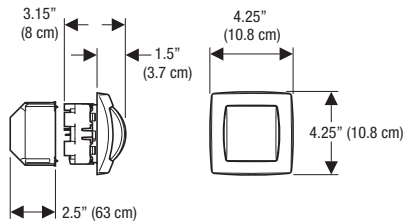

## Finishes

Single-Flush Actuator Plates for 111.728.00.X Toilet Carrier (UP720 flush tank) (Fig. 1)

Style	Material	Finish	Model No.
Mambo	Stainless Steel	Brushed SS	115.751.00.1†



Style	Material	Finish	Model No.
Tango	Zinc die cast	Alpine White	115.760.11.1
		Polished Chrome	115.760.21.1
		Matte Chrome	115.760.46.1
		Oil Rubbed Bronze	115.760.HM.1†
		ForeverShine™	115.760.IB.1†
		PVD Polished Nickel	
		ForeverShine™	115.760.ID.1†
		PVD Brushed Nickel	



Single-Flush Push Button for 111.728.00.X Toilet Carrier (UP720 flush tank) (Fig. 2)

HyTouch WC Square	Plastic	Alpine White	115.991.11.1†
		Gloss-Matte**	115.991.KA.1†



\*\*Colors follow this pattern = Frame/Button  
† Special order. Up to 4 weeks delivery. Contact your Geberit sales representative or customer service for more information.

## Warranty

One-year warranty on actuator flush panels. ForeverShine™ finishes installed in residential-use applications are warranted not to corrode, tarnish or discolor for the life of the Product.

## Features

- Designed to maintain appearance push after push
- Moving parts are accessible behind actuator flush panel
- Made of molded plastic, zinc die cast or stainless steel and plated
- Available in 28 designer finishes
- Initiates flush of 1.6 GPF (6 LPF)



### ARCHITECT/ENGINEER APPROVAL

Job Name \_\_\_\_\_

Date \_\_\_\_\_ Quantity \_\_\_\_\_

Model Specified \_\_\_\_\_

Variations Specified \_\_\_\_\_

Customer/Wholesaler \_\_\_\_\_

Contractor \_\_\_\_\_

Architect \_\_\_\_\_

Product specifications subject to change without notice.

Geberit  
2100 S. Clearwater Drive  
Des Plaines, IL 60018

800/566-2100  
Fax 847/803-5454  
www.geberit.us

GEB6117 08/10

GNAT106 08/10