

Wall-Hung Washdown Toilet Carriers

Replacement Parts for Wall-Hung Washdown Toilet Carrier 111.335.00.5 and 111.335.00.6

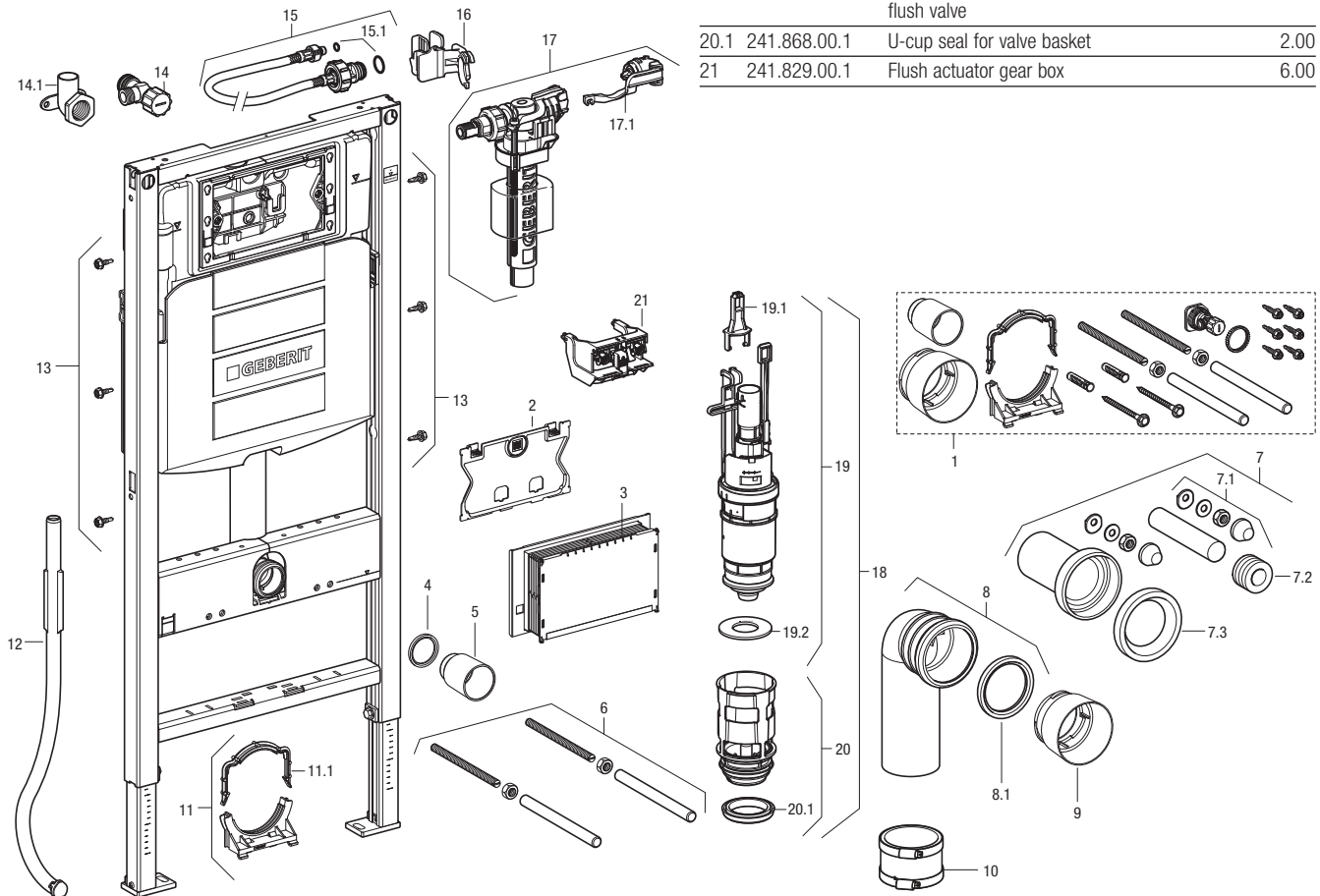



Item No.	Model No.	Description	List Price
1	241.869.00.1	Installation materials for concealed carrier and tank	\$39.00
2	241.824.00.1	Splash guard protection cover for UP320	6.00
3	241.826.00.1	Mud guard protection housing for UP320, Plastic	11.00
4	362.771.00.1	Seal for concealed flush pipe, EPDM	2.00
5	362.796.92.1	Protection plug, Plastic	5.00
6	240.189.00.1	Threaded rod for wall-mounted toilet or bidet installation	4.00
7	152.404.46.1	Connector set with mounting hardware (bowl installation kit), HDPE; Matte chrome cover caps	38.00
7.1	217.713.46.1	Cover caps with leveling washer, Plastic, Matte chrome	5.00
7.2	119.668.00.1	Seal for supply inlet tube, EPDM	2.00
7.3	152.424.00.1	Seal for toilet outlet connector, EPDM	3.00
8	366.061.16.1	Waste fitting outlet bend, HDPE	18.00
8.1	387.282.00.1	Seal for outlet bends, EPDM	5.00

Item No.	Model No.	Description	List Price
9	366.820.92.1	Protection plug, Plastic	\$4.00
10	240.782.00.1	Flexible Coupling for pipes	62.00
11	242.012.00.1	Outlet pipe bracket (complete)	4.00
11.1	242.017.00.1	Outlet pipe bracket handle	5.00
12	242.010.00.1	Conduit pipe for shower toilet water supply with UP300 and UP320 concealed tank	5.00
13	111.892.00.1	Frame mounting screws for steel stud construction, Galvanized; self-tapping	3.00
14	240.853.00.1	Supply angle Stop, 1/2" NPT male	14.00
14.1	240.851.00.1	Drop Ear Elbow, copper; 5/8" copper tubing x 1/2" NPT female	11.00
15	240.921.00.1	Connection hose for concealed tank, 3/8"	14.00
15.1	240.922.00.1	Seal kit for braided hose, EPDM O-Ring	9.00
16	240.923.00.1	Fixation clip for filling valve	6.00
17	241.469.00.1	Impuls380 Fill valve for concealed tanks	24.00
17.1	240.771.00.1	Seal kit for Impuls380 fill valve	11.00
18	241.858.00.1	Dual-flush valve complete with valve seat basket	12.00
19	240.622.00.1	Dual-flush valve for concealed tank	12.00
19.1	241.167.00.1	Yoke set for flush valves	9.00
19.2	816.418.00.1	Flat gasket for flush valve	2.00
20	241.859.00.1	Valve seat basket and noise bushing for flush valve	9.00
20.1	241.868.00.1	U-cup seal for valve basket	2.00
21	241.829.00.1	Flush actuator gear box	6.00



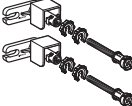
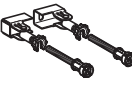

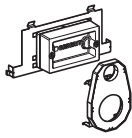
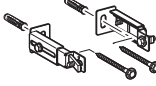

Optional Parts for Wall-Hung Washdown Toilet Carrier 111.335.00.5

Mounting Accessories for Carrier Frames

Description	Model No.	List Price
 Frame to wall anchoring for 5.12"–7.87" (13–20 cm) thick unfinished pre-wall	111.815.00.1	\$30.00
 Frame to wall anchoring for 5.12"–7.87" (13–20 cm) thick unfinished pre-wall corner installations	111.835.00.1	30.00
 Support brackets for wall-hung toilets with small contact surface (thin profiles)	111.847.00.1	66.00
 Fire protection set for UP320 concealed dual-flush tanks; 90 min. fire resistance to DIN EN 1364-1:1999-10	111.863.00.1	464.00
 Frame to wall anchoring where foot installations into floor are not allowed for 5.12"–7.87" (13–20 cm) thick unfinished pre-wall	111.867.00.1	61.00
 Frame to stud fastening set for extended stud spacing from 19.75"–25.56" (50–65 cm)	111.869.00.1	30.00
 Frame to wall anchoring extensions for 7.87"–15.75" (20–40 cm) thick unfinished pre-wall	111.887.00.1	11.00

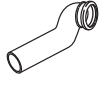

Waste Fittings

 HDPE straight connector with socket for Ø3.54" (Ø90 mm) push fit piping and Ø3.54" (Ø90 mm) outlet x 12" (31 cm) long	366.887.16.1	27.00
 HDPE connector with offset for LH horizontal drain connections (as viewed from sitting position), 1 x 90° bend with socket for Ø3.54" (Ø90 mm) push fit piping, with 45° offset and Ø3.54" (Ø90 mm) outlet	366.913.16.1	61.00
 HDPE connector with offset for RH horizontal drain connections (as viewed from sitting position), 1 x 90° bend with socket for Ø3.54" (Ø90 mm) push fit piping, with 45° offset and Ø3.54" (Ø90 mm) outlet	366.914.16.1	61.00
 Cast iron outlet bend; 1 x 90° bend with socket for Ø3.54" (Ø90 mm) push fit piping and 3" CIP outlet	367.071.18.1	127.00

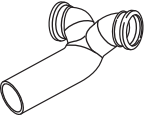
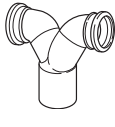

Mounting Accessories for Carrier Frames (continued)

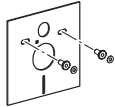
Description	Model No.	List Price
 HDPE "Back-to-back" connector for horizontal drain connections; 2 x 90° bends with sockets for Ø3.54" (Ø90 mm) push fit piping, with 45° offset and expansion to Ø4.33" (Ø110 mm) outlet	367.485.16.1	\$127.00
 HDPE "Back-to-back" connector for vertical drain connections; 2 x 90° bends with sockets for Ø3.54" (Ø90 mm) push fit piping and expansion to Ø4.33" (Ø110 mm) outlet	367.923.16.1	127.00

Bowl Connection Sets and Accessories

 HDPE connection set with 1" (2.5 cm) offset and mounting hardware (bowl installation kit); with socket for Ø3.54" (Ø90 mm) push fit piping and Ø55 mm supply inlet; matte chrome cover caps	405.116.00.1	205.00
 Acoustic insulation set for wall-hung toilets and bidets	156.050.00.1	15.00
 Cover caps with leveling washer, Alpine white	217.713.11.1	5.00

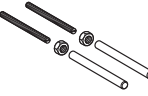
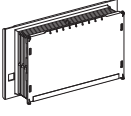
Required Accessories for 3.54"–7.09" (9–18 cm) Finished Wall Thickness

 Mounting rod extension set for wall-hung toilet and bidet, M12	242.232.00.1	20.00
 Mud guard protection housing for UP320 flush tanks	241.826.00.1	11.00
 Extension set for actuator flush plates compatible with UP320, UP300, and UP200 flush tanks	240.938.00.1	19.00
 HDPE Connector set for extended installation and mounting hardware (bowl installation kit), with socket for Ø3.54" (Ø90 mm) push fit piping and Ø55 mm supply inlet; matte chrome cover caps	152.438.46.1	50.00